

step09

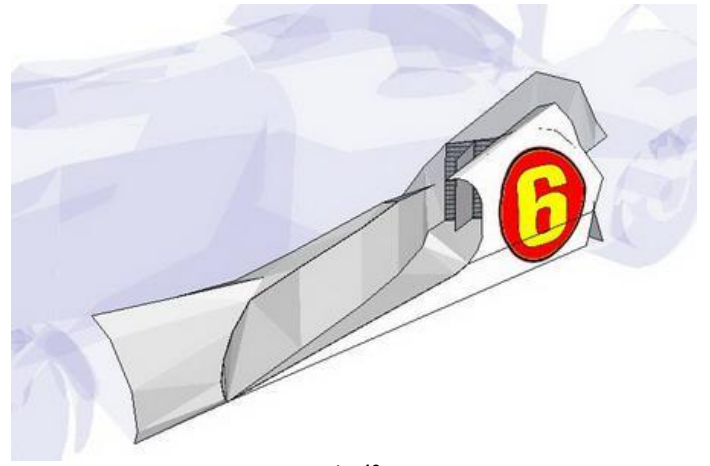

step13

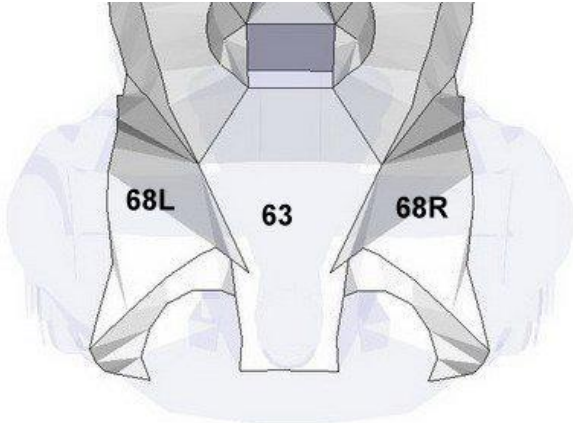

step10

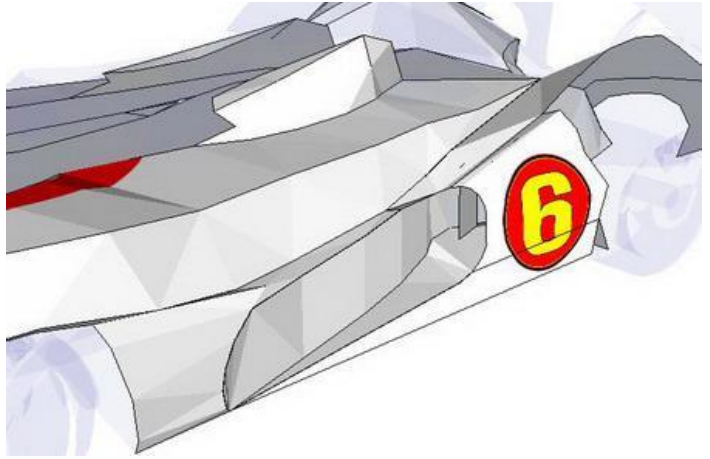

step14

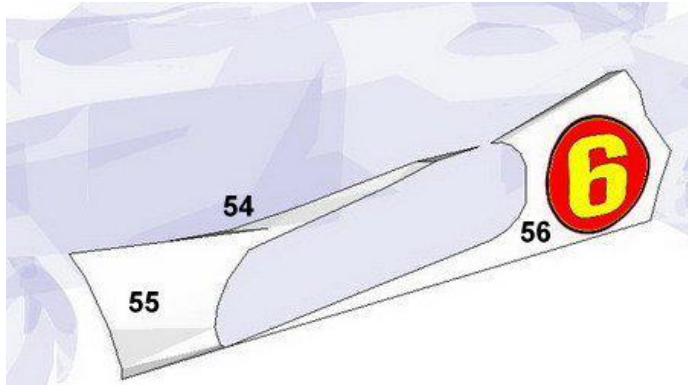

Parts 55 and 56 are NOT glued one to another

step11

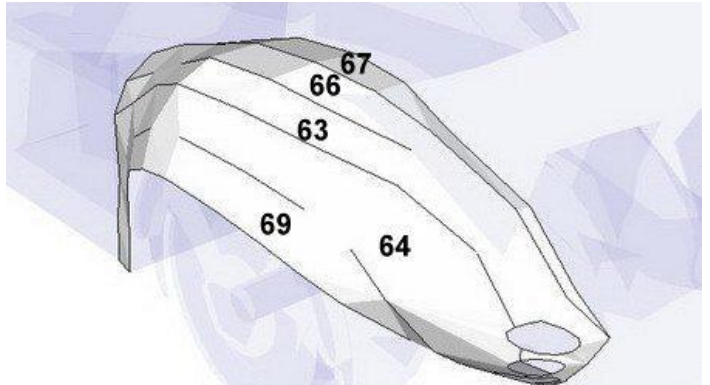

step15

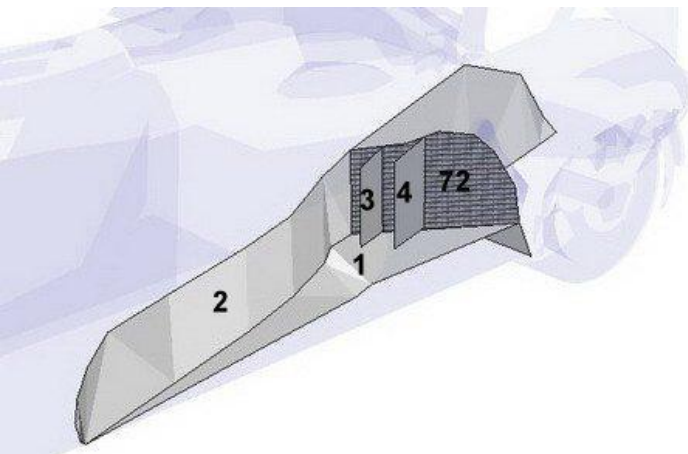

step12

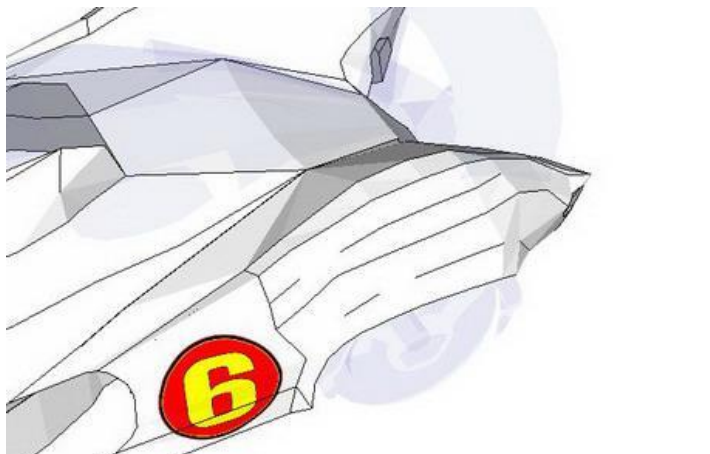

step16

Cut part 71 from a transparent sheet to make the windshield

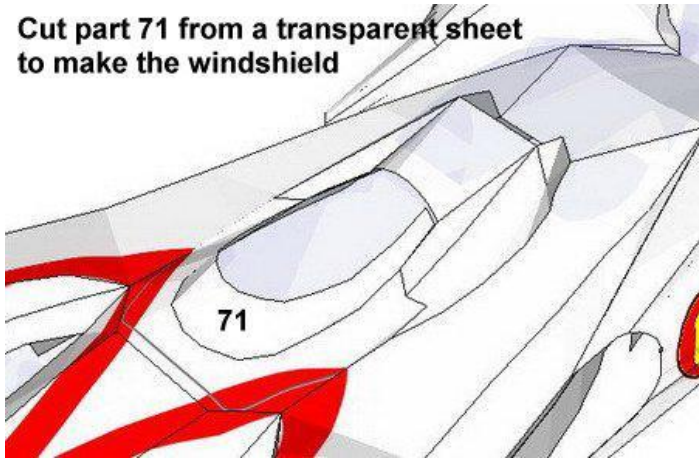

step17

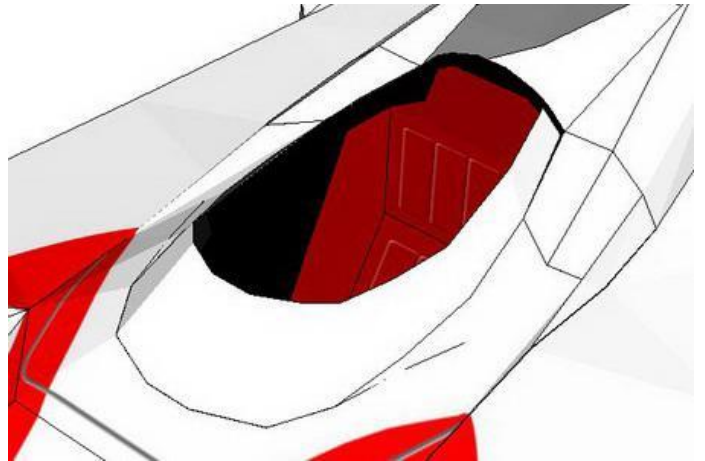

step20a

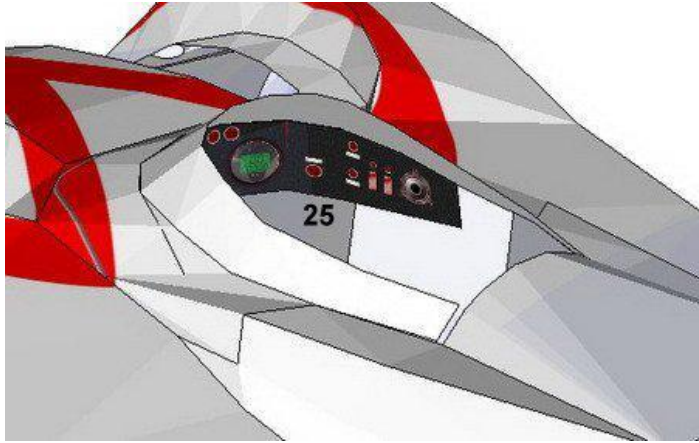

step18

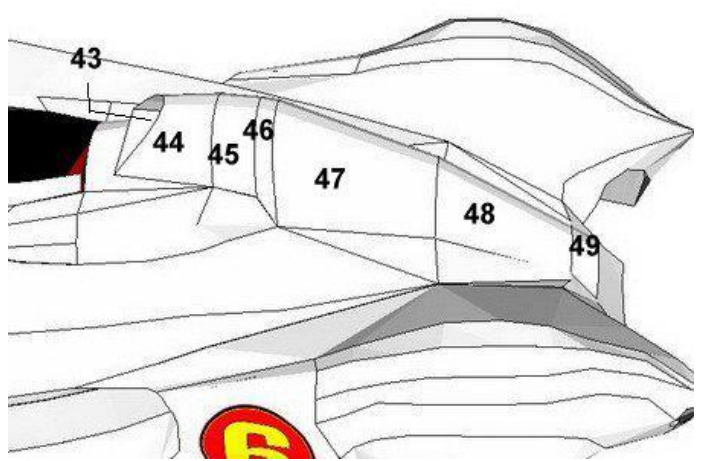

step21

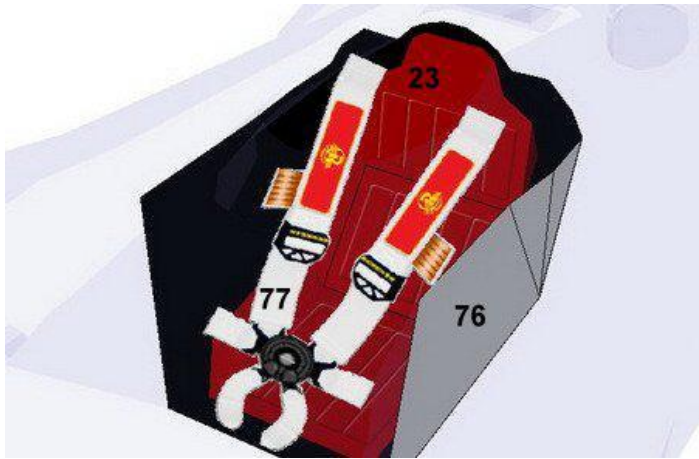

step19

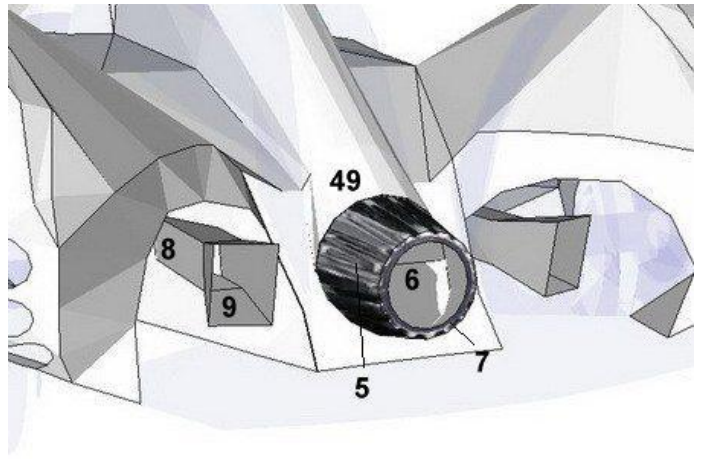

step22

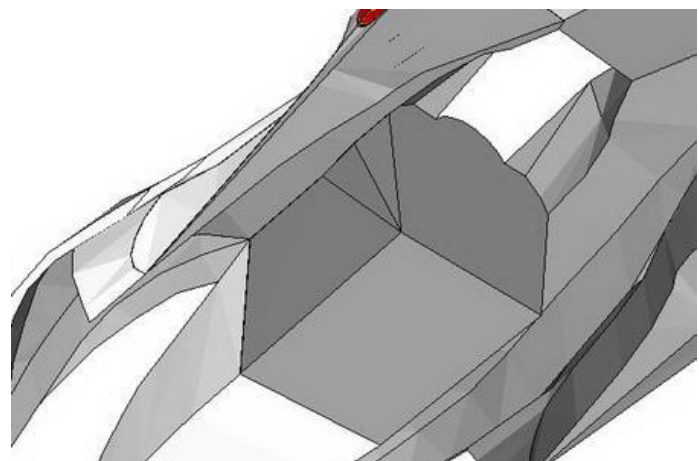

step20

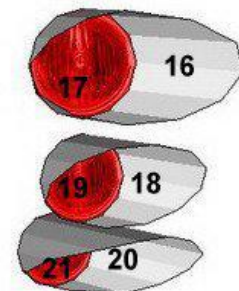

step23

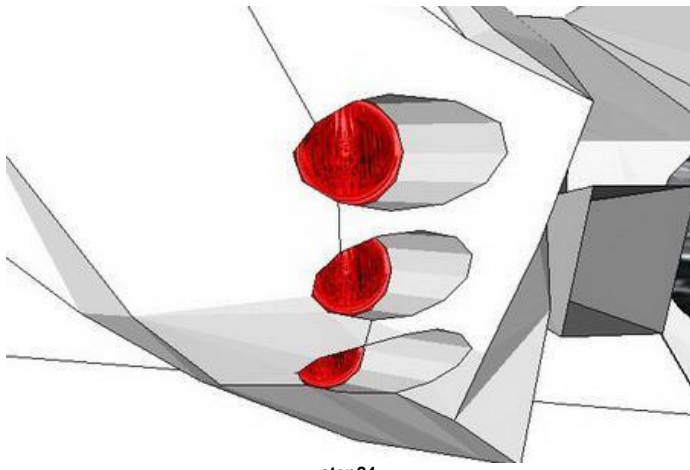

step24

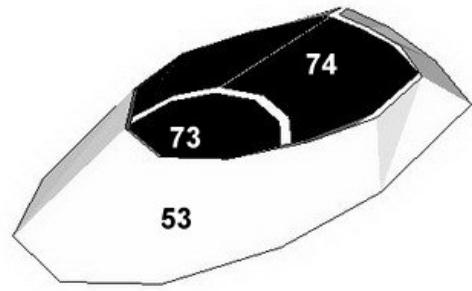

step28

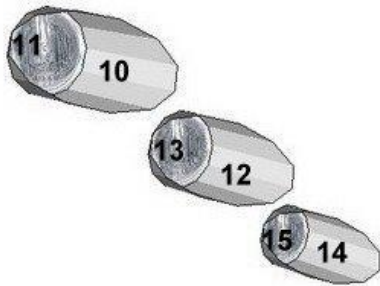

step25



step29

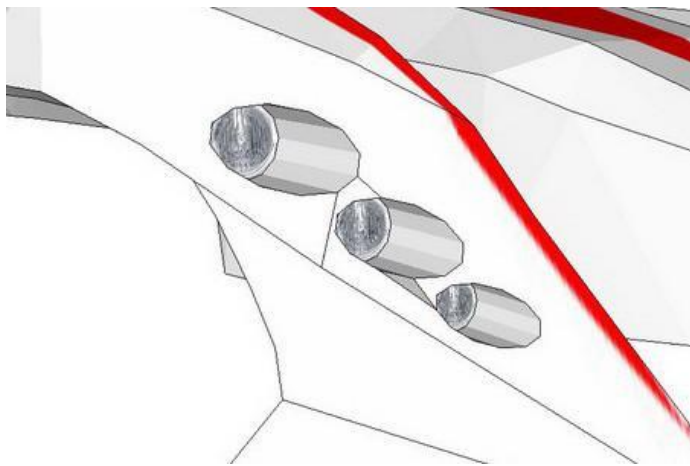

step26

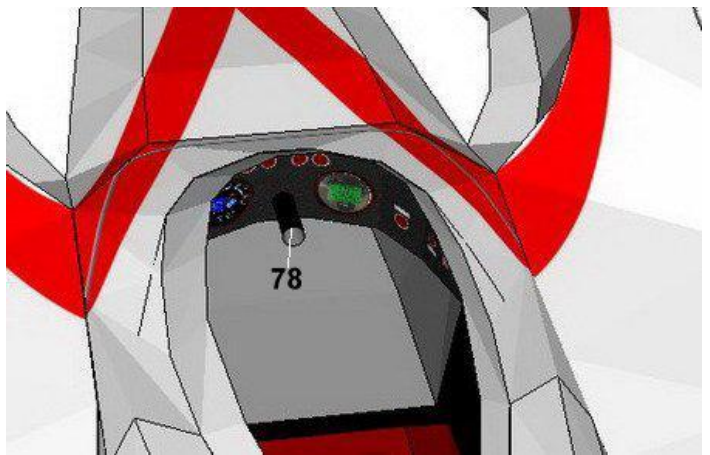

step30

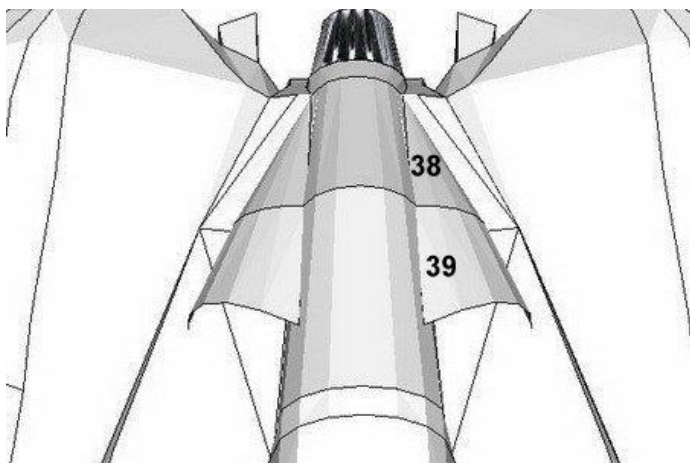

step27

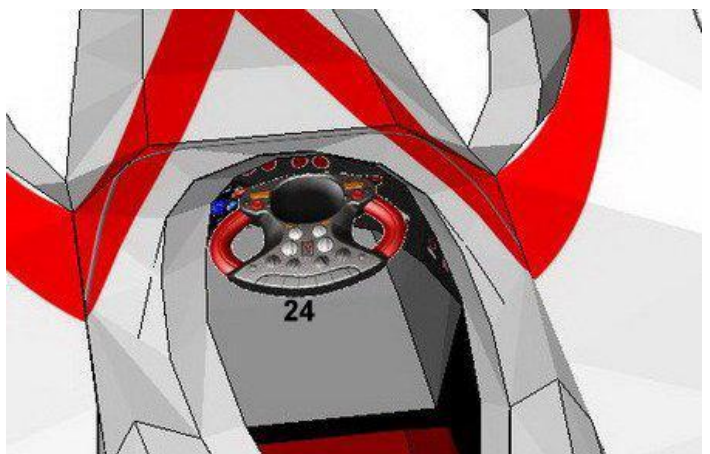

step31

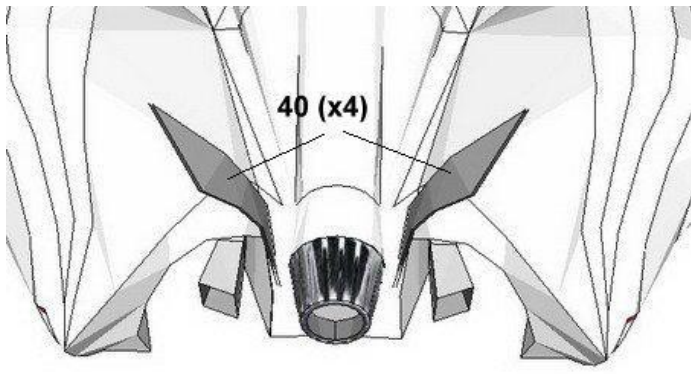

step32

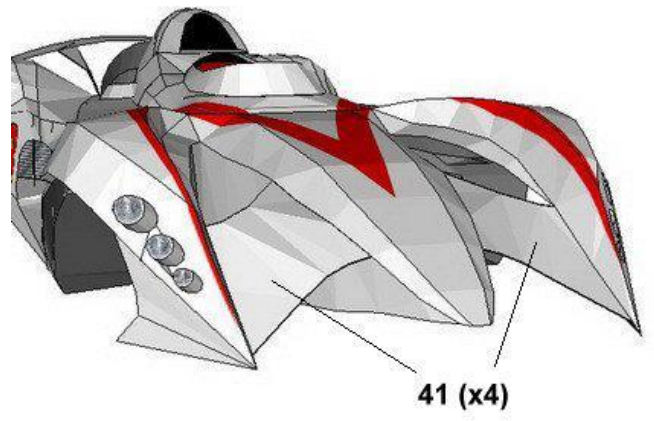

step35

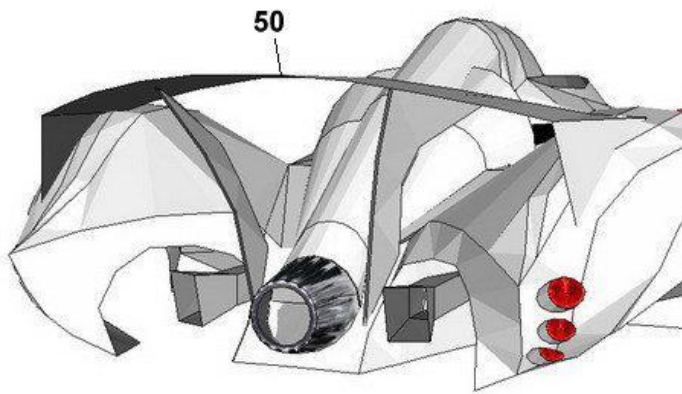

step33

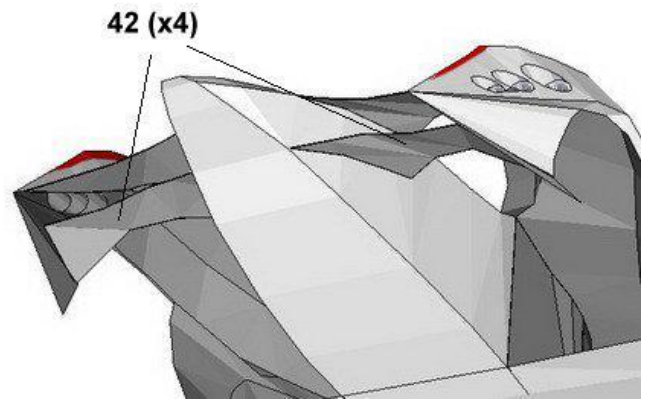

step36

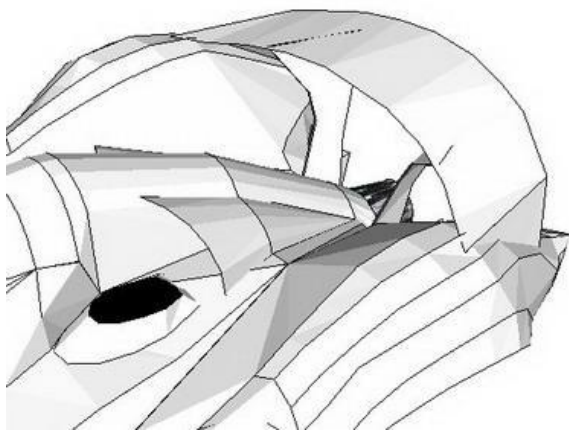

step33a

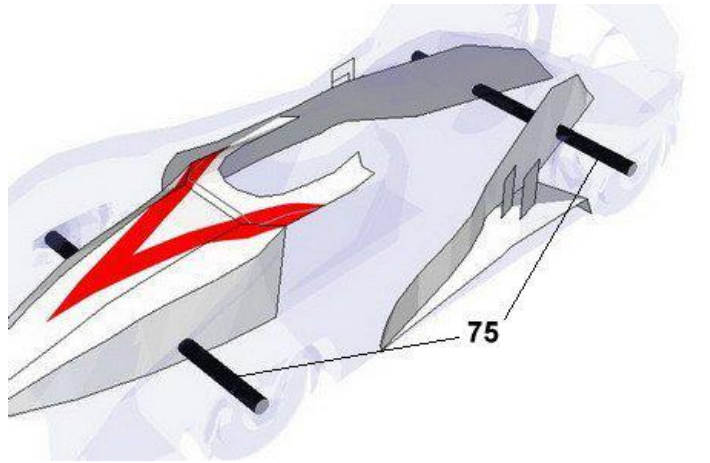

step37

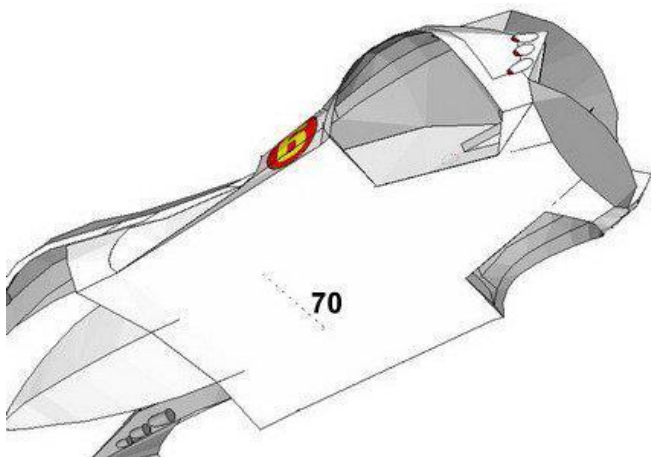

step34

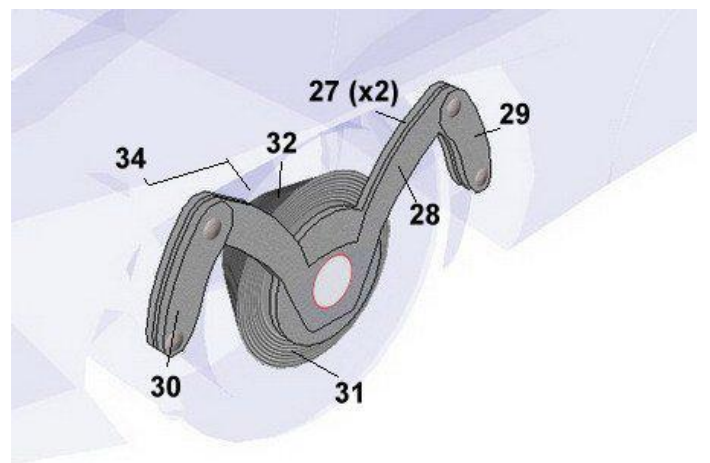

step38

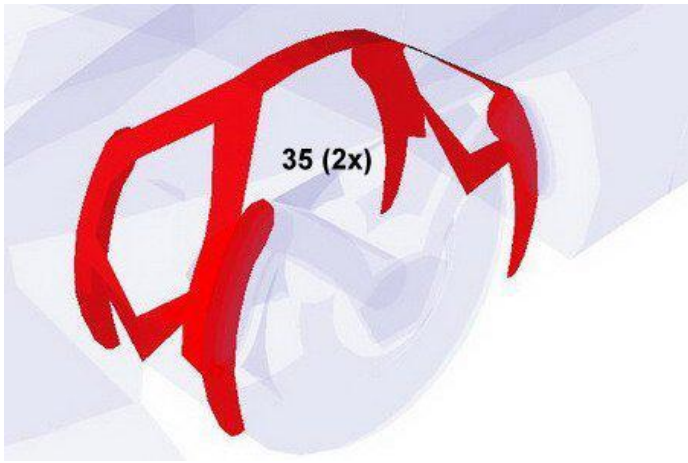

step39



step43



step40



step41

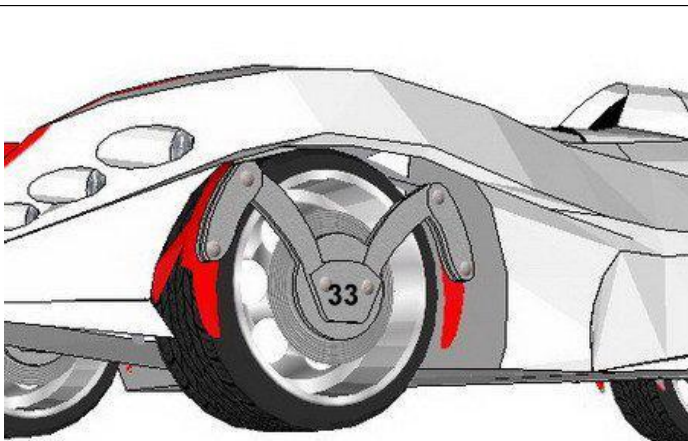

step42